

HF High Pass Filter Design

By Mark Gluch

Using a design from Ajarn Changpuak www.changpuak.ch and his web site calculator

Received June 12th 2017

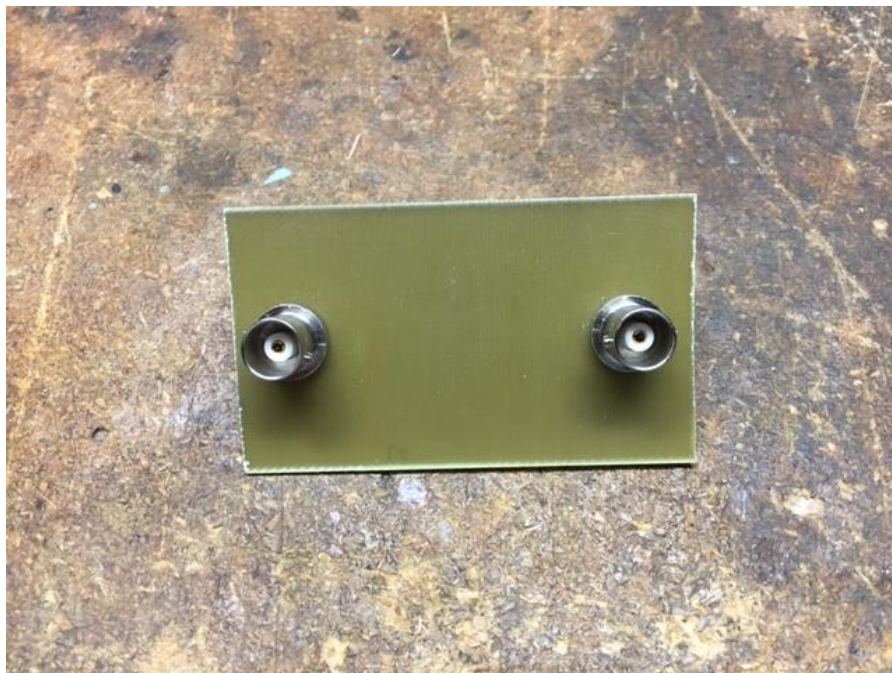
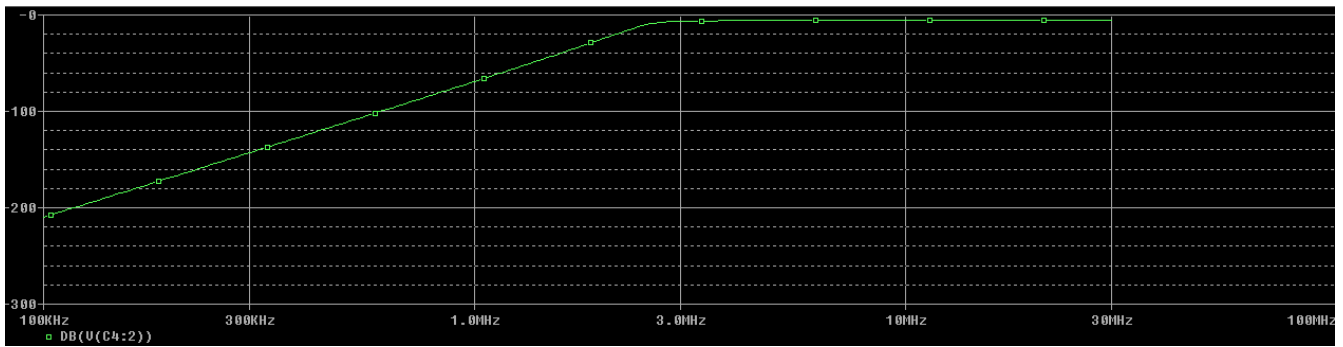
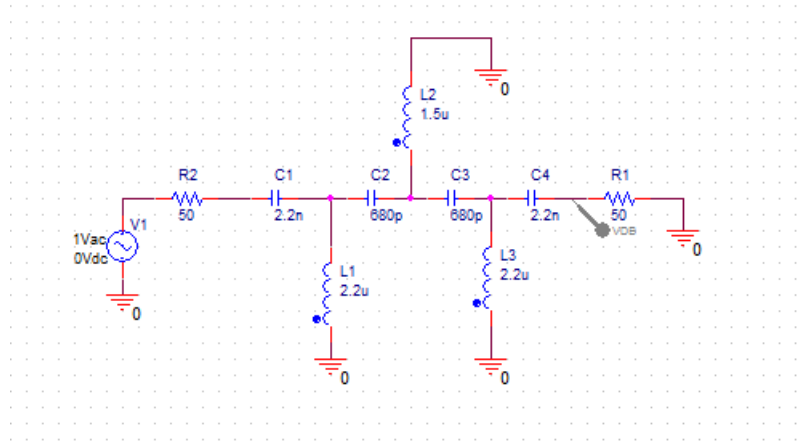

80m dipole direct to spectrum analyzer input:

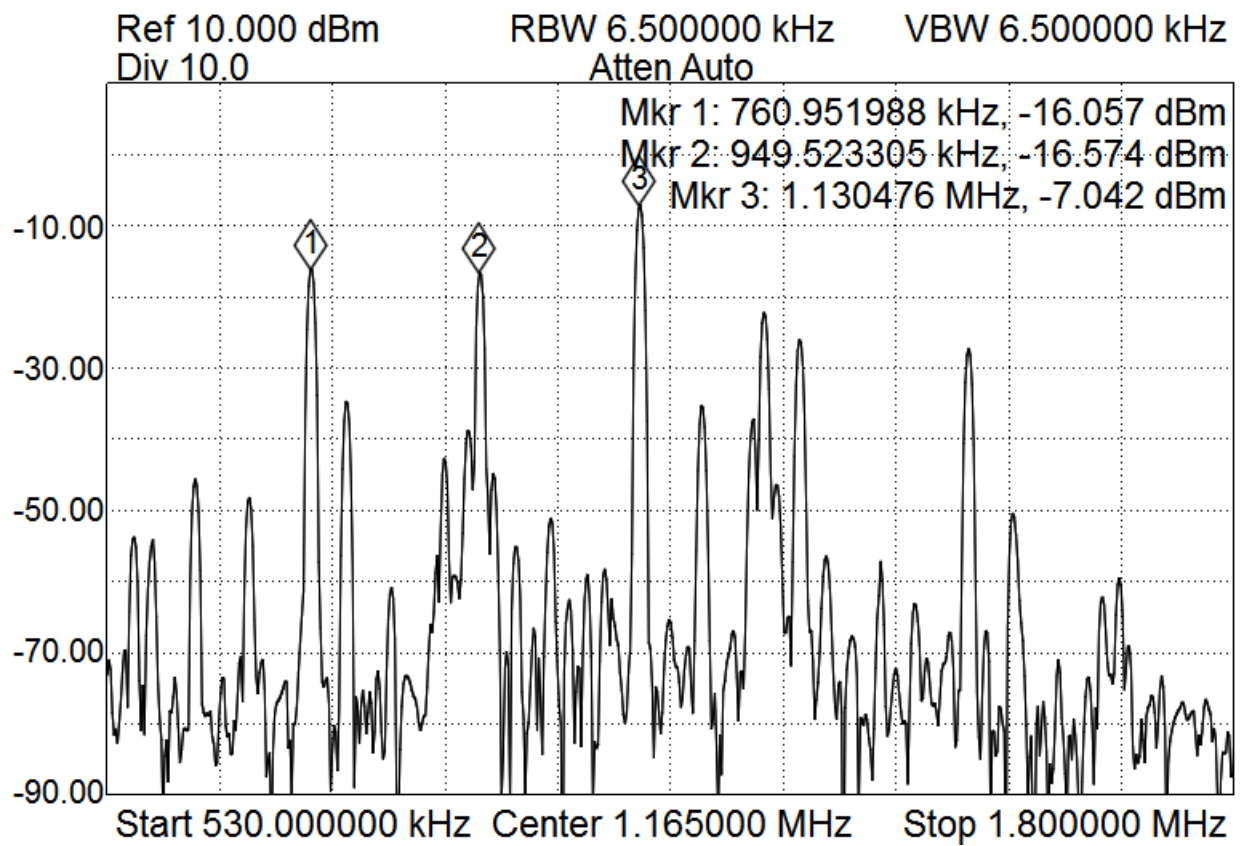

80m dipole through high pass filter to spectrum analyzer input:

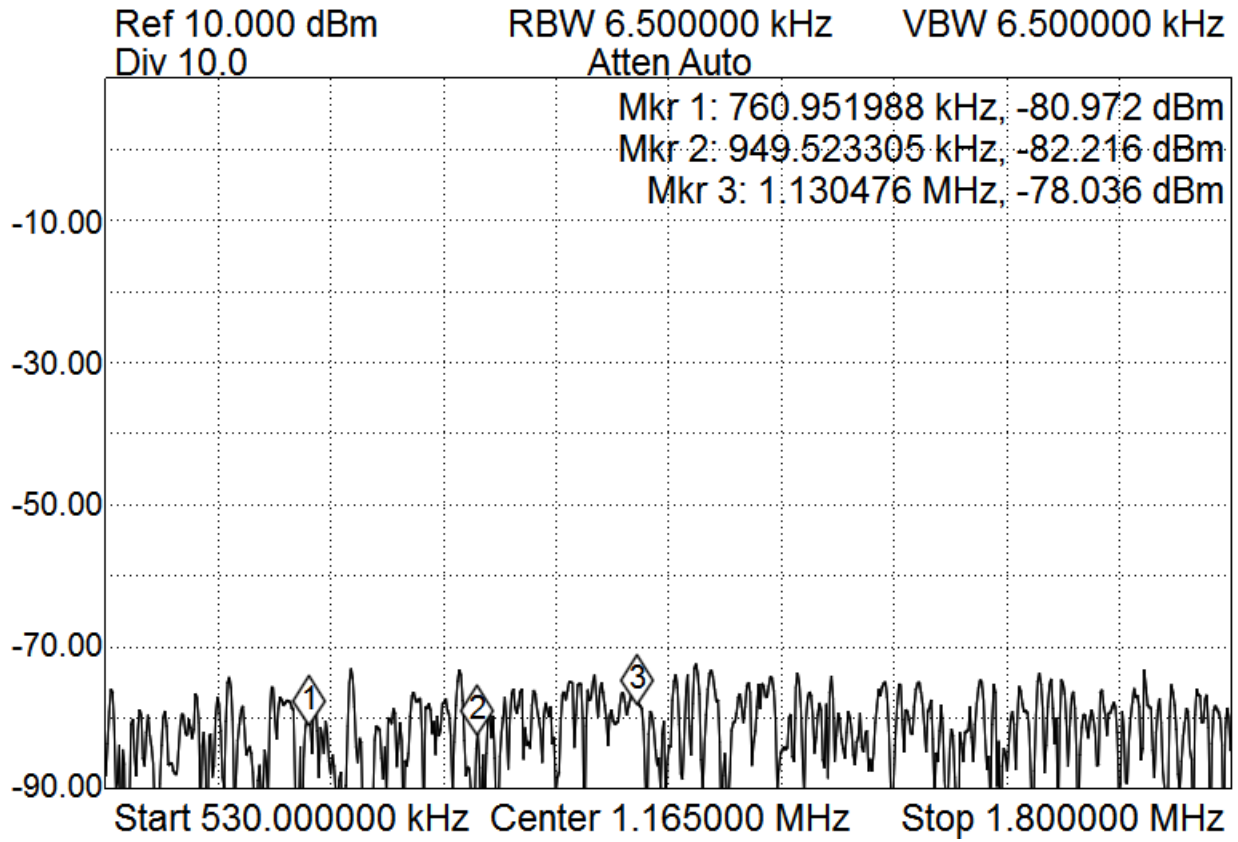

100 kHz to 30 MHz sweep of high pass filter:

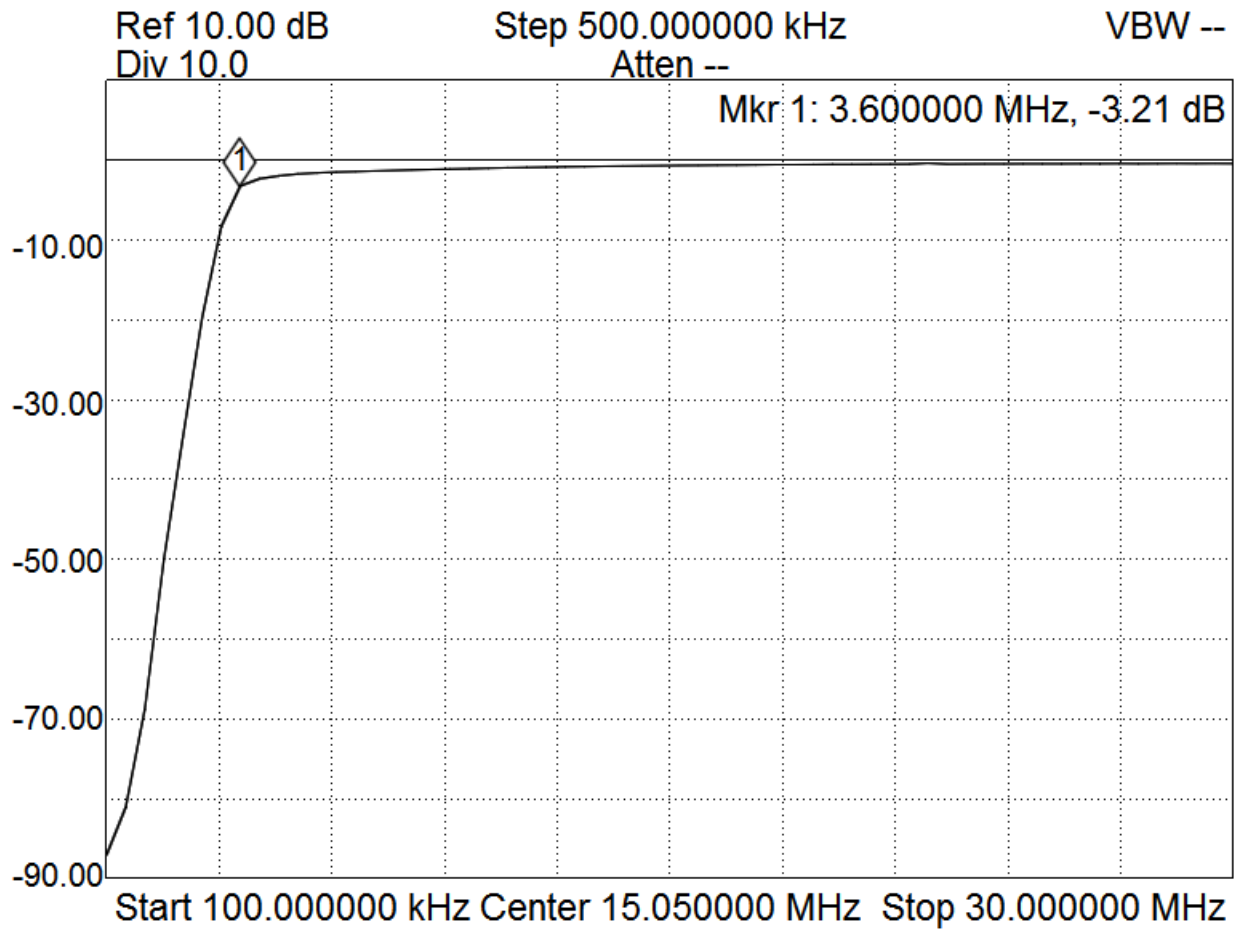

No HPF:

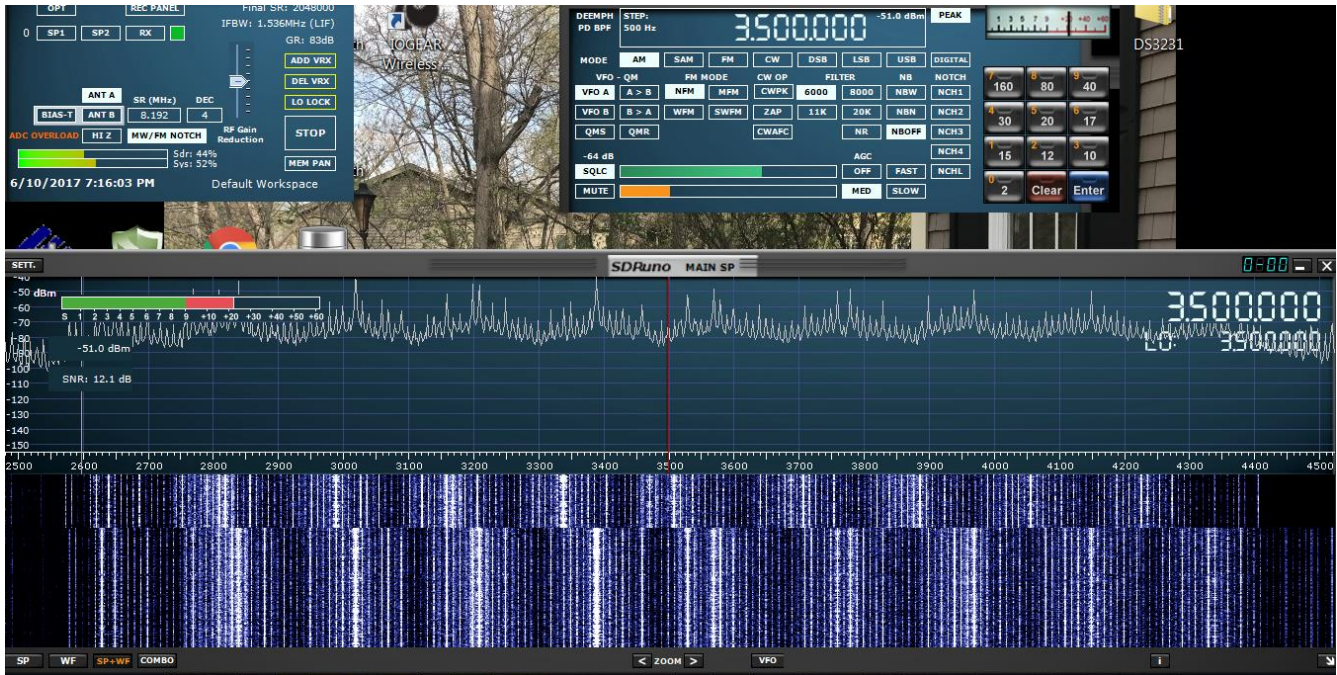

HPF Installed:

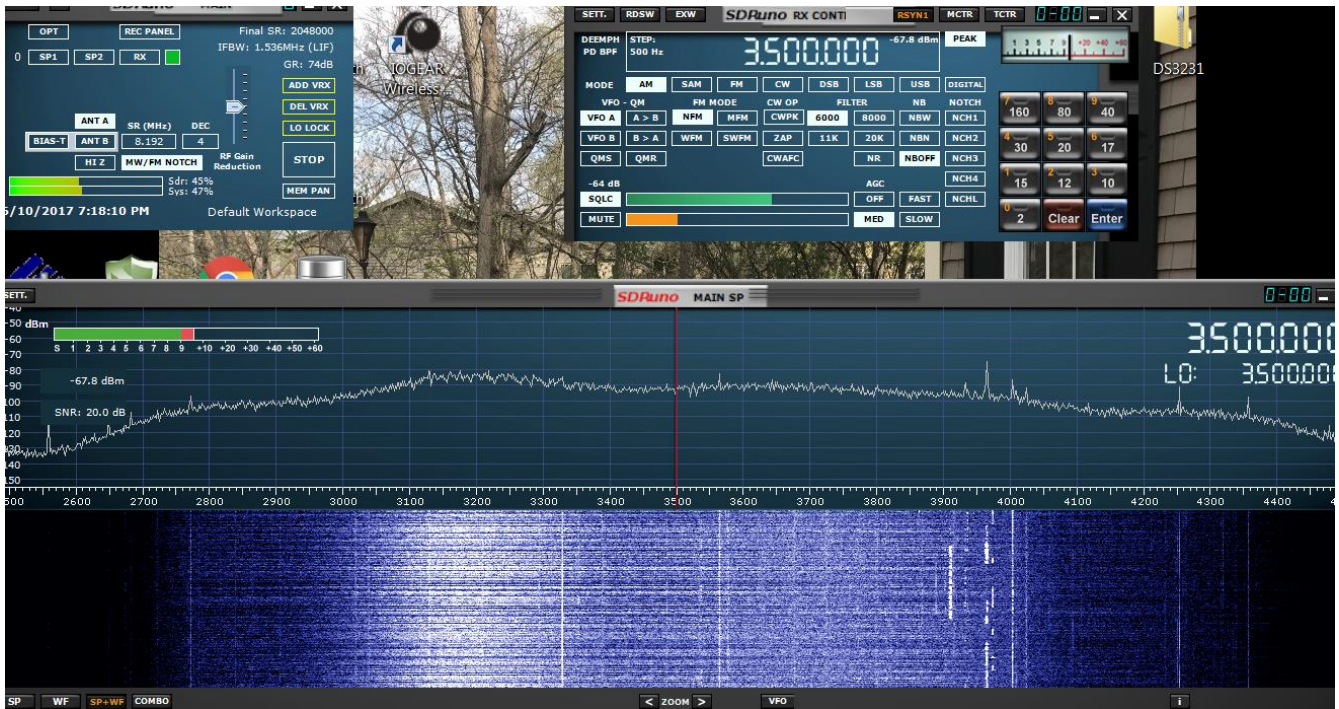

Mark Glutch June 2017